

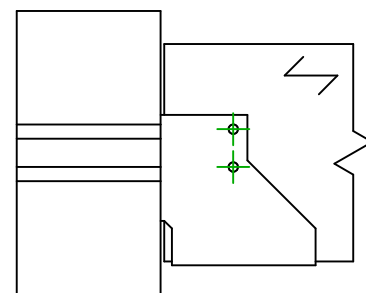

Codici =	BSIN200	
Mezzo di giunzione =	Legno a legno	Travetto a trave
Tipo di fissaggio =	Chiodatura completa	

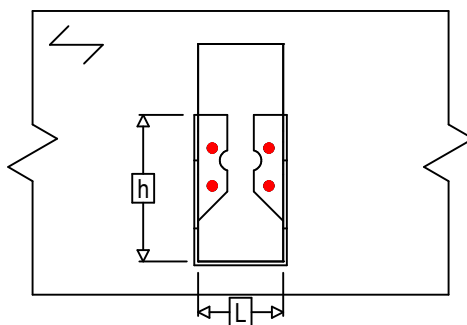

$$h = (200 - L) / 2$$

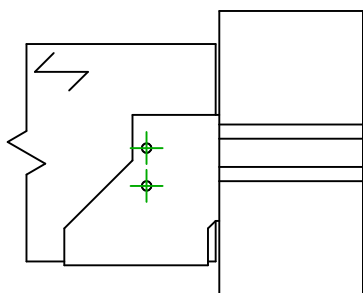
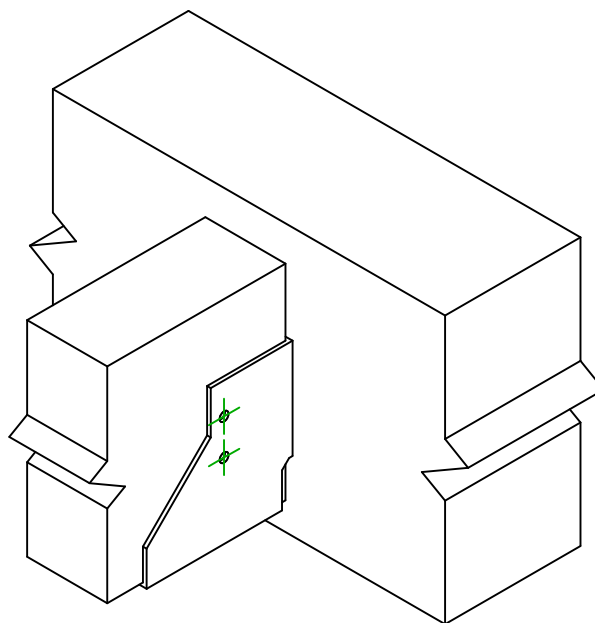

Fissaggio supporto	Simbolo	Mezzo di giunzione	Mezzo di giunzione		Q.tà	
		CNA		CNA4.0X35 / CNA4.0X50		4
		CSA		CSA5.0X35 / CSA5.0X40		
-		-	-			
Fissaggio travetto	Simbolo	Mezzo di giunzione	L < 64mm	L > 64mm	Q.tà	
		CNA		CNA4.0X35	CNA4.0X50	4
		CSA		CSA5.0X35	CSA5.0X40	